



WARN Industrial Hoist

Model

Part Number

Motor Type

DC1200

64254

DC Electric
12 Volt
Permanent
Magnet

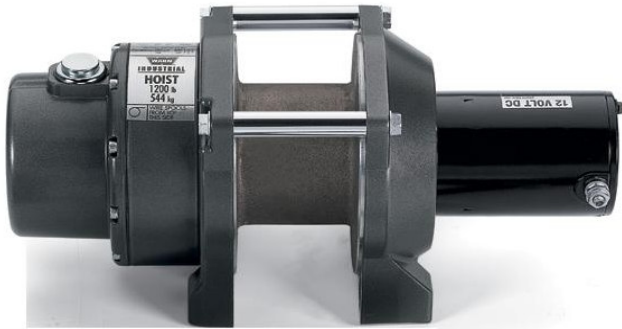

The DC1200 hoist combines a powerful permanent magnet DC motor with robust sealing and our proven 3-stage all metal geartrain. Permanent grease lubrication means years of trouble free service. All WARN hoists incorporate an automatic mechanical brake that holds full rated load. The durable powder coated finish stands up to the elements and looks great. The DC1200 hoist is built on a compact midsize framed with integrated tie bars that's easy to install. Controls and accessories available separately.

Accessories

Description:	Part Number
Control Pack-12V	63926
Contactors Only-12V (Standard bracket)	83321
Contactors Cover (with remote plug)	36648
Contactors Cover (no plug)	35169
Remote Control Only	34462

Engineering Data

Rated Capacity:	1200 lbf	544 kgf
Drum Barrel Diameter:	3.5 in	89 mm
Drum Flange Diameter:	6.0 in	152 mm
Distance Between Flanges:	2.7 in	69 mm
Recommended Maximum Wire Rope Diameter:	3/16 in	4.8 mm
Recommended Minimum Wire Rope Breaking Strength:	4200 lbf	1905 kgf
Approximate Shipping Weight:	27.0 lb	12.2 kg
Duty Cycle (intermittent per SAE J706 section 6.2):	N/A ft	N/A m
Mounting Bolt Torque:	32 - 34 ft*lb	43 - 46 N*m
Maximum Layers of Wire Rope:	4	
Gear Reduction:	216:1	
Brake Type:	Automatic Cone	
Contactors/Remote Type:	Not Included	

Drum Rotation



Viewed from Motor End

Standards Compliance

- CE Machinery Directive 98/37/EC and 2006/42/EC
- CE Electromagnetic Compatibility 2004/108/EC
- ASME B30.5

Performance By Layer

Drum Layer	Line Load *			No Load Line Speed		Drum Capacity	
	lbf	kgf	kN	ft/min	m/min	ft	m
1	1200	544	5.3	23.5	7.2	13	4.0
2	1090	494	4.8	25.8	7.9	27	8.2
3	1000	454	4.4	28.2	8.6	42	12.8
4	920	417	4.1	30.6	9.3	58	17.7

* Never exceed the Rated Capacity. Installation of a Rated Capacity Limiter is recommended.

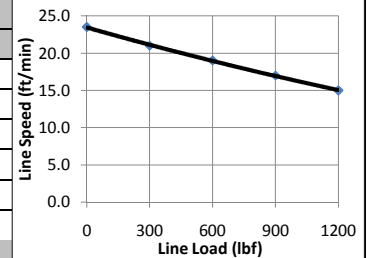

First Layer Performance

Line Load		Current Draw	Line Speed		Duty Cycle
lbf	kgf	Amps	ft/min	m/min	min/10min
0	0	20	23.5	7.2	2.5
300	136	39	21.0	6.4	2.2
600	272	57	19.0	5.8	1.9
900	408	77	17.0	5.2	1.6
1200	544	100	15.0	4.6	1.3

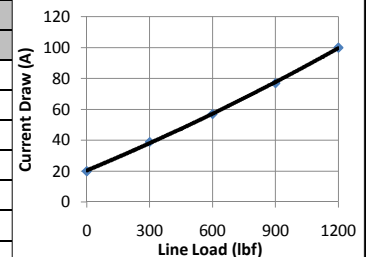

WARN INDUSTRIES, INC
Industrial Products

Customer Service (North America): 1.800.543.9276
Customer Service (International): 1.503.722.3008
FAX: 1.503.722.3000 www.warn.com

12900 S.E. Capps Road,
Clackamas, OR USA 97015





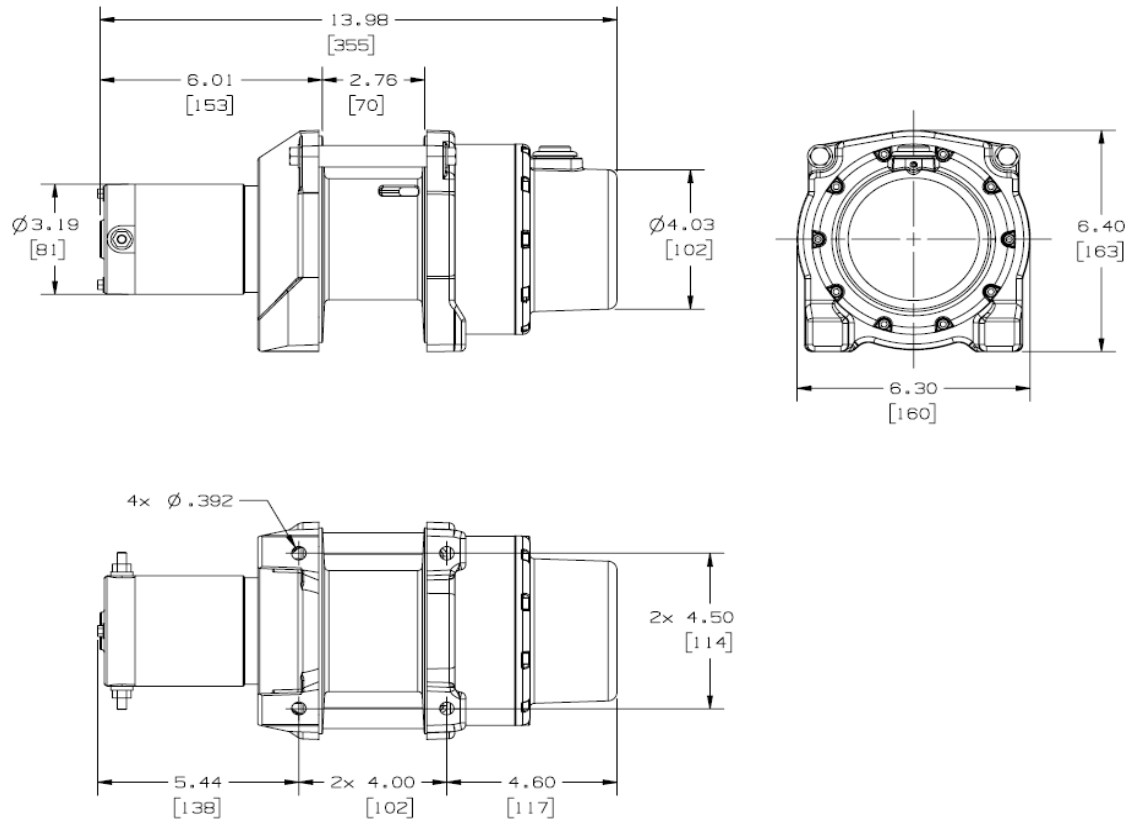

WARN Industrial Hoist

Model	Part Number	Motor Type
DC1200	64254	DC Electric 12 Volt Permanent Magnet

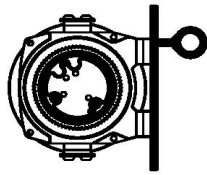
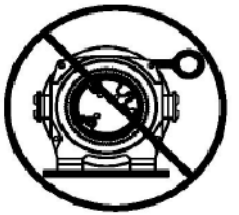

Units are given in inches [millimeters], unless otherwise specified

Recommended Mounting (Always Observe Correct Drum Rotation)			Electrical System Specifications
Pull from bottom of hoist  Feet down	Pull from bottom of hoist  Feet forward	Pull from top of hoist  Feet forward	See Electrical Cable Gauge Size Chart for cable sizing All electrical connections must be clean and tight
Electrical System Wiring Schematic Hoist provided without electrical controls. See accessories on front page for control kits. Power IN (Hoisting)- Connect motor terminal #2 to positive. Connect motor terminal #1 to negative (Ground). Power OUT (Lowering)- Connect motor terminal #1 to positive. Connect motor terminal #2 to negative (Ground).			
Pull from top of hoist  Feet down without angle brace	Pull from top of hoist  Feet down with angle brace	Pull from top of hoist  Angle Braces Only	Notes:

WARN INDUSTRIES, INC
Industrial Products

Customer Service (North America): 1.800.543.9276
 Customer Service (International): 1.503.722.3008
 FAX: 1.503.722.3000 www.warn.com

12900 S.E. Capps Road,
Clackamas, OR USA 97015